



*Complete Freeze Protection for Process Instrumentation*

*为过程仪表提供全面的防冻保护*

*Totaal pakket voor de vorstbeveiliging van uw proces instrumentatie*

*Protection-basse température complète pour l'instrumentation*

*Kompletter Frostschutz für Prozess-Instrumentierung*

*Completa protezione antigelo per strumentazione di processo*

*Komplett frostsikring av prosess instrumenter*

*Комплексная защита от замерзания приборов и процессных линий кипи*

*Completa Proteccion Contra Congelacion Para Instrumentacion de Proceso*

# TRACEPAK<sup>®</sup>

**Design | Enclosures | Supports | Tubing Bundle | Installation**



## An engineered, preinsulated tubing bundle system

### **TRACEPAK solves problems for analytical, instrumentation and mechanical plant utility applications:**

- ▼ Freezing,
- ▼ Dew point Component drop-out,
- ▼ Viscosity,
- ▼ Personnel protection

Freezing, dew point, component drop-out and viscosity control are major considerations in instrument impulse connections, small diameter process lines and analyzer sample transport. A properly designed and selected pretraced tubing bundle offers an effective solution to these problems.

### **The economical choice to field fabrication**

Maintenance free TRACEPAK not only saves money and time during the installation process, but it ensures consistent, repeatable performance. Field fabrication requires a pipe fitter to lay out, measure, cut, dress, bend and install the tubing. Next the tracer (steam or electric) has to be installed and insulation put on the tubing. Finally, a weatherproof covering needs to be applied over the insulation. Clearly the economics of the TRACEPAK system versus field fabrication are significant.

### **Provides predictable and repeatable performance**

O'Brien, long recognized as the leader in providing reliable instrumentation protection, has simplified installation while offering predictable operation. TRACEPAK tube bundles are prefabricated, pre-engineered and preinsulated assemblies.

Installation is simplified by the unique parallel configuration, in which process and tracer lines are always parallel inside the bundle. The bundle is much easier to bend during field routing and hookup because all tubes bend together and not against one another.

### **Connections are easy because tubing stays round and is not work hardened**

TRACEPAK's configuration allows the tubing to stay round and malleable when used in conjunction with compression and flare fittings. The installation of process and instrument connections requires only a simple, one-plane offset bend to engage tubing and fittings.

### **Can be installed at temperatures as low as -40°**

O'Brien Corporation utilizes the highest quality materials. Our TPU jacket contains no halogens, eliminating the possibility of chlorides from the jacket causing stress corrosion in stainless steel tubing. This jacket has excellent abrasion and chemical resistance along with a wide, usable temperature range. TRACEPAK can be installed in temperatures as low as -40°.

### **Common types of pretraced lines:**

- ▼ Electric traced lines, TPE, for freeze protection and maintenance of temperature.
- ▼ Steam traced lines, TPL & TPH, for freeze protection and temperature maintenance.
- ▼ Single preinsulated line, S-LINE, primarily for steam supply and condensate return.

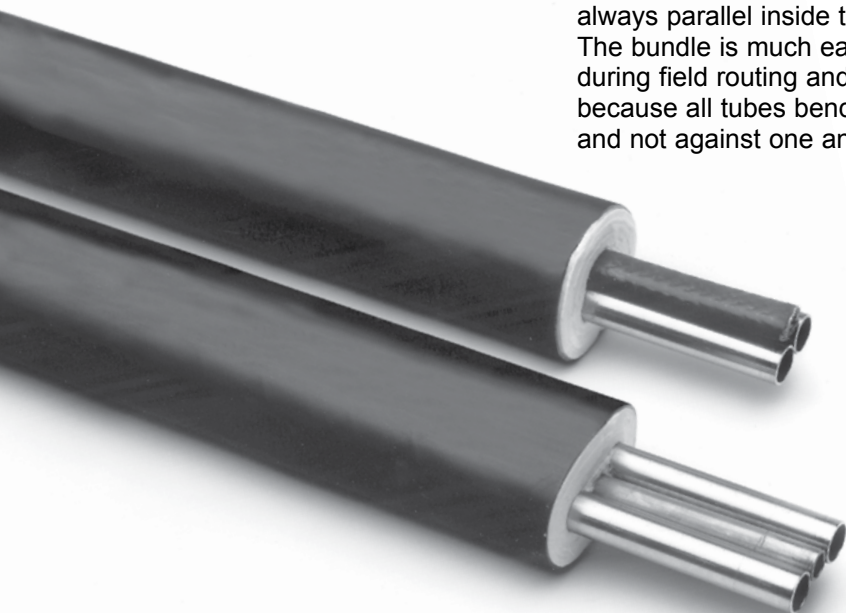

Specifications subject to change without notice.

## Systems Approach

Protecting instrumentation and tubing from freezing or maintaining process fluids at elevated temperatures involves many components, designs and engineering skills. Instead of specifying and purchasing individual components, have O'Brien provide an integrated solution with one source responsibility.

**DESIGN and SUPPORT** for impulse lines and instrument freeze protection combined with field support services sets the O'Brien solution apart from all others.

**TRACEPAK®** engineered, preinsulated tubing bundle for instrument impulse, sample transport, and small diameter process lines.

**VIPAK®** engineered enclosure system designed for process instrumentation. **TRAKMOUNT®** and factory installation of instrumentation makes field work easy.

The typical way.



The O'Brien solution.

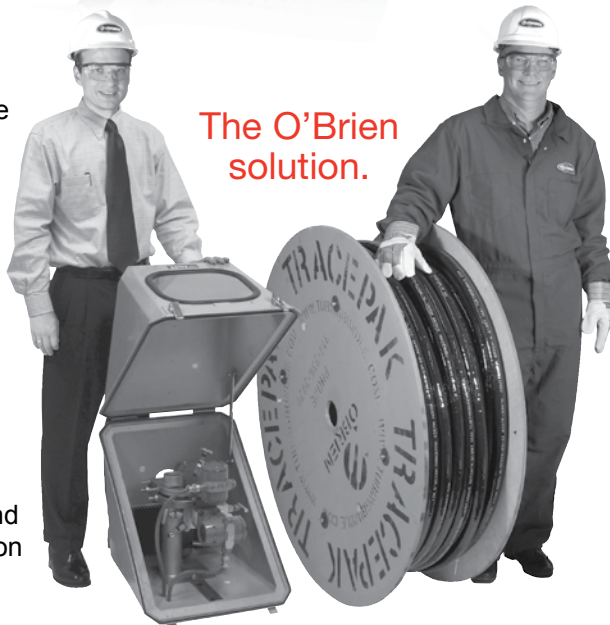

### Typical applications for the TRACEPAK system:

#### INSTRUMENT IMPULSE LINES

- flow transmitters
- pressure transmitters
- level transmitters
- pressure switches
- controllers

#### ANALYZER SAMPLE LINES

- process analyzers
- chromatographs
- emissions monitoring

#### MECHANICAL AND PLANT UTILITY PROCESS LINES

- steam supply
- condensate return
- water purge
- chemical feed
- air lines

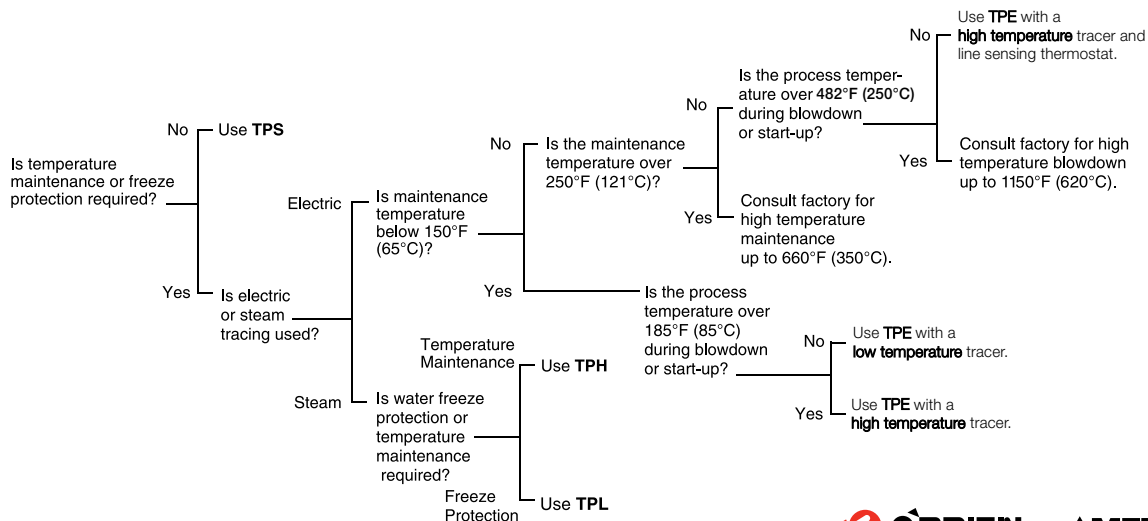



# TPE SELF REGULATING

## A preinsulated tubing bundle with self regulating electric tracing

TPE is designed to maintain freeze protection, close temperature tolerances or viscosity control.

It provides an excellent means of maintaining very long, continuous lengths of impulse lines and piping at consistent temperatures end-to-end. TPE should be chosen when electric tracing is preferred, steam is not available or when the steam supply could be interrupted such as during shutdowns.

Use TPE if the allowable temperature ranges from 50°F (10°C) to 250°F (121°C). Because it is self regulating, this system will lower its heat output as the process tube gets warmer. When close temperature control is necessary, TPE can be utilized with an optional line sensing thermostat.

### Electric tracer

Standard TPE-Self Regulating products utilize two electric tracers approved for use in hazardous areas when installed with the recommended power connection kits.

The high temperature, Self Regulating Tracer:

1. Withstands 482°F (250°C) intermittent blowdown temperatures.
2. Can maintain temperatures up to 250°F (120°C).

The low temperature Self Regulating Tracer:

1. Withstands up to 185°F (85°C) intermittent blowdown temperatures.
2. Can maintain temperatures up to 150°F (65°C).

The choice between high and low temperature tracers must be made based on the desired performance and the conditions of the application.

Other designs are available to maintain temperatures up to 350°F (180°C) and withstand 1150°F (620°C) blowdown conditions. Consult factory for specific design.

### Typical Performance

Each graph shows typical performance splitting summer/winter ambients. Each line is separated at 60°F (15°C) to designate the seasonal differences.

Winter ambients, below 60°F (15°C), assume a 25 mph (40 Km/H) wind and summer ambients, above 60°F (15°C), assume a 10 mph (16 Km/H) wind. For freeze protection, use 50°F (10°C) as the minimum allowable process tube temperature. This will provide a sufficient factor of safety.

### Dimensions

	NOMINAL WT. LB/FT (KG/M)	NOMINAL DIMENSIONS - IN (CM)	
		A	B
TPE1- One 1/4" Process Tubes	0.3 (0.45)	1.1 (2.8)	1.0 (2.5)
TPE1- One 3/8" Process Tubes	0.4 (0.60)	1.3 (3.3)	1.0 (2.5)
TPE1- One 1/2" Process Tubes	0.5 (0.74)	1.4 (3.6)	1.1 (2.8)
TPE2- Two 1/4" Process Tubes	0.4 (0.60)	1.3 (3.3)	1.1 (2.8)
TPE2- Two 3/8" Process Tubes	0.6 (0.89)	1.5 (3.8)	1.2 (3.0)
TPE2- Two 1/2" Process Tubes	0.8 (1.19)	1.7 (4.3)	1.4 (3.6)

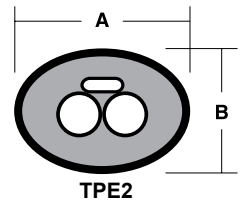
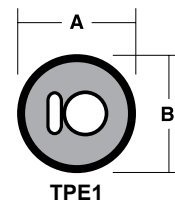

TPE1 - ONE 1/2" (12mm) PROCESS LINE WITH LOW TEMPERATURE TRACER

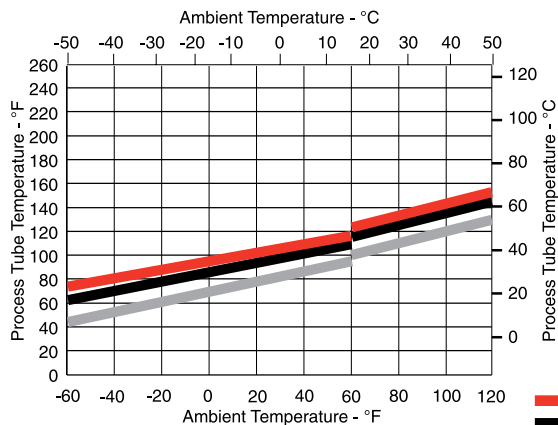

TPE2 - TWO 1/2" (12mm) PROCESS LINES WITH LOW TEMPERATURE TRACER

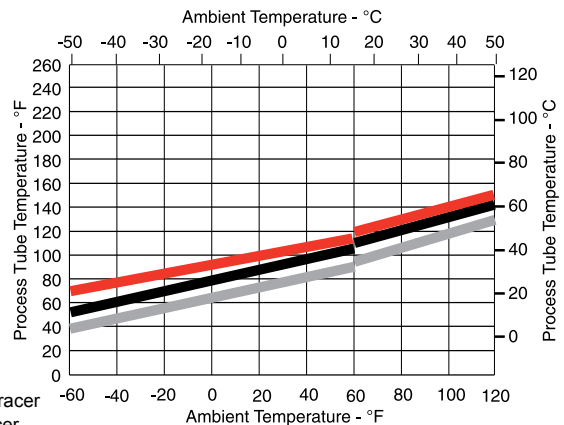

Performance shown at 120V and 240V.



**Model Number**

**Product Family**

**TPE1-** Preinsulated Electrically Traced Single Process Tube

**TPE2-** Preinsulated Electrically Traced Dual Process Tubes

**Jacket**

**S** - SV47 (PVC)

**U** - TPU (Polyurethane)

**Process Tube**

- A2** 1/4" x 0.035 wall welded 316SS
- A3** 3/8" x 0.035 wall welded 316SS
- A4** 1/2" x 0.035 wall welded 316SS
- E4** 1/2" x 0.049 wall welded 316SS
- F1** 1/8" x 0.035 wall seamless 316SS
- F2** 1/4" x 0.035 wall seamless 316SS
- F3** 3/8" x 0.035 wall seamless 316SS
- F4** 1/2" x 0.035 wall seamless 316SS
- B2** 1/4" x 0.049 wall seamless 316SS
- B3** 3/8" x 0.049 wall seamless 316SS
- B4** 1/2" x 0.049 wall seamless 316SS
- B6** 3/4" x 0.049 wall seamless 316SS
- G2** 1/4" x 0.030 wall PFA
- G3** 3/8" x 0.030 wall PFA
- H3** 3/8" x 0.062 wall PFA
- H4** 1/2" x 0.062 wall PFA
- K4** 1/2" x 0.065 wall seamless 316SS
- S2** 1/4" x 0.040 wall extruded PFA
- MF6** 6mm x 1mm wall seamless 316SS
- MF8** 8mm x 1mm wall seamless 316SS
- MF10** 10mm x 1mm wall seamless 316SS
- MF12** 12mm x 1mm wall seamless 316SS
- MB10** 10mm x 1.5mm wall seamless 316SS
- MB12** 12mm x 1.5mm wall seamless 316SS
- MG6** 6mm x 1mm wall PFA
- MG8** 8mm x 1mm wall PFA
- MG10** 10mm x 1mm wall PFA
- MG12** 12mm x 1mm wall PFA
- MA12** 12mm x 1mm wall welded 316SS

**Tracer**

**High Temperature Tracer**

- B5-** 5w/ft (16w/m) self-regulating heater @ 50°F (10°C), 100 - 130V
- B10-** 10w/ft (29w/m) self-regulating heater @ 50°F (10°C), 100 - 130V
- B15-** 15w/ft (47w/m) self-regulating heater @ 50°F (10°C), 100 - 130V
- B20-** 20w/ft (63w/m) self-regulating heater @ 50°F (10°C), 100 - 130V
- N5-** 5w/ft (16w/m) self-regulating heater @ 50°F (10°C), 200 - 277V
- N10-** 10w/ft (29w/m) self-regulating heater @ 50°F (10°C), 200 - 277V
- N15-** 15w/ft (47w/m) self-regulating heater @ 50°F (10°C), 200 - 277V
- N20-** 20w/ft (63w/m) self-regulating heater @ 50°F (10°C), 200 - 277V

**Low Temperature Tracer**

- J5-** 5w/ft (16w/m) self-regulating heater @ 50°F (10°C), 100 - 130V
- J8-** 8w/ft (25w/m) self-regulating heater @ 50°F (10°C), 100 - 130V
- J10-** 10w/ft (29w/m) self-regulating heater @ 50°F (10°C), 100 - 130V
- P5-** 5w/ft (16w/m) self-regulating heater @ 50°F (10°C), 200 - 277V
- P8-** 8w/ft (25w/m) self-regulating heater @ 50°F (10°C), 240vac
- P10-** 10w/ft (29w/m) self-regulating heater @ 10°C, 240vac

**Specialty Tracers**

- JV10-** 10w/ft (29w/m) power-limiting heater @ 50°F (10°C), 100 - 130V
- JV20-** 20w/ft (63w/m) power-limiting heater @ 50°F (10°C), 100 - 130V
- JN10-** 10w/ft (29w/m) power-limiting heater @ 50°F (10°C), 200 - 277V
- JN20-** 20w/ft (63w/m) power-limiting heater @ 50°F (10°C), 200 - 277V

Standard tracers have a tinned copper shield and fluoropolymer outer jacket. They are approved to ATEX, CSA, and NEC standards for use in hazardous areas. Most configurations are rated for T3 or lower maximum temperatures. Consult factory for specific approvals.

**Example:**

**TPE2S-A4-B5**

Two 1/2" x 0.035 wall 316SS welded process lines with an SV47 jacket and a 5w/ft (16w/m) tracer.

For specific information regarding each of these products, consult the factory or your local representative.

**TPE1 - ONE 1/2" (12mm) PROCESS LINE WITH HIGH TEMPERATURE TRACER**

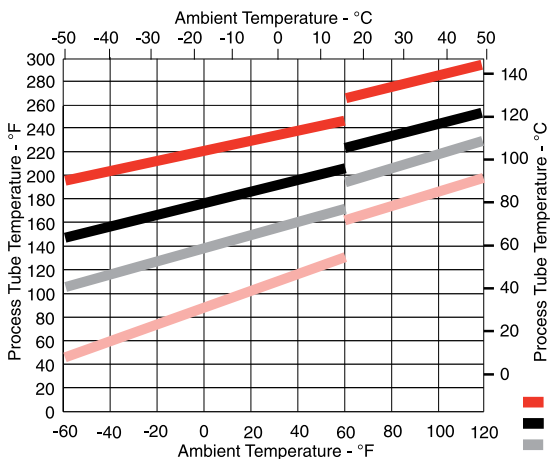

**TPE2 - TWO 1/2" (12mm) PROCESS LINES WITH HIGH TEMPERATURE TRACER**

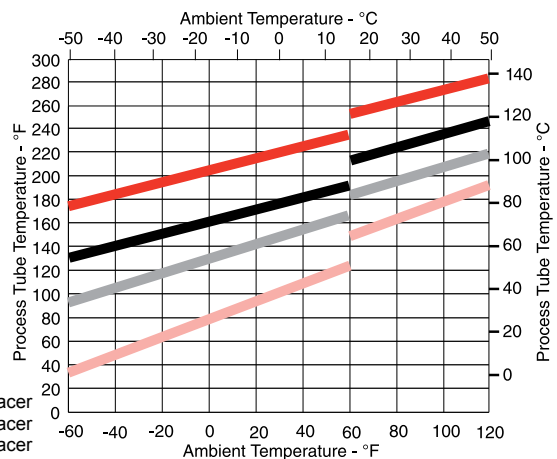

Performance shown at 120V and 240V.

# TPL LIGHT STEAM TRACING

## A preinsulated tubing bundle with light steam tracing

The tracer tube is wrapped with insulation to purposely reduce heat transfer.

TPL can maintain temperatures between 50°F (10°C) and 200°F (95°C). It provides a more constant tube temperature over a longer length than heavy traced designs.

It is suited for small diameter process lines such as those used for instrumentation, sampling and additives.

TPL is recommended for freeze protection of instrument impulse lines as well as the process lines for analyzers.

### Model Number

### Product Family

**TPL1**-Preinsulated Light Steam Traced

Single Process Tube

**TPL2**-Preinsulated Light Steam Traced

Dual Process Tubes

### Jacket

**S** - SV47 (PVC)

**U** - TPU (Polyurethane)



- MG6** 6mm x 1mm wall PFA
- MG8** 8mm x 1mm wall PFA
- MG10** 10mm x 1mm wall PFA
- MG12** 12mm x 1mm wall PFA
- MA12** 12mm x 1mm wall welded 316SS
- N2** 1/4" x 0.035 wall seamless Alloy 400
- N3** 3/8" x 0.035 wall seamless Alloy 400
- P4** 1/2" x 0.049 wall seamless Alloy 400

*This is a condensed list of tube and tracer options. For a full product offering consult factory.*

### Process Tube

- A2** 1/4" x 0.035 wall welded 316SS
- A3** 3/8" x 0.035 wall welded 316SS
- A4** 1/2" x 0.035 wall welded 316SS
- E4** 1/2" x 0.049 wall welded 316SS
- F1** 1/8" x 0.035 wall seamless 316SS
- F2** 1/4" x 0.035 wall seamless 316SS
- F3** 3/8" x 0.035 wall seamless 316SS
- F4** 1/2" x 0.035 wall seamless 316SS
- B2** 1/4" x 0.049 wall seamless 316SS
- B3** 3/8" x 0.049 wall seamless 316SS
- B4** 1/2" x 0.049 wall seamless 316SS
- B6** 3/4" x 0.049 wall seamless 316SS
- K4** 1/2" x 0.065 wall seamless 316SS
- G2** 1/4" x 0.030 wall PFA
- G3** 3/8" x 0.030 wall PFA
- H3** 3/8" x 0.062 wall PFA
- H4** 1/2" x 0.062 wall PFA
- S2** 1/4" x 0.040 wall PFA
- MF6** 6mm x 1mm wall seamless 316SS
- MF8** 8mm x 1mm wall seamless 316SS
- MF10** 10mm x 1mm wall seamless 316SS
- MF12** 12mm x 1mm wall seamless 316SS
- MB10** 10mm x 1.5mm wall seamless 316SS
- MB12** 12mm x 1.5mm wall seamless 316SS

### Tracer

- A2** 1/4" x 0.035 wall welded 316SS
- A3** 3/8" x 0.035 wall welded 316SS
- A4** 1/2" x 0.035 wall welded 316SS
- F2** 1/4" x 0.035 wall seamless 316SS
- F3** 3/8" x 0.035 wall seamless 316SS
- B4** 1/2" x 0.049 wall seamless 316SS
- J2** 1/4" x 0.030 wall copper
- C3** 3/8" x 0.032 wall copper
- M4** 1/2" x 0.049 wall copper
- MF6** 6mm x 1mm wall seamless 316SS
- MF8** 8mm x 1mm wall seamless 316SS
- MF10** 10mm x 1mm wall seamless 316SS
- MF12** 12mm x 1mm wall seamless 316SS
- MD6** 6mm x 1mm wall copper
- MD8** 8mm x 1mm wall copper
- MD10** 10mm x 1mm wall copper
- MD12** 12mm x 1mm wall copper

### Example:

#### TPL2S-A4-C3

Two 1/2" x 0.035 wall 316SS welded process lines with an SV47 jacket and 3/8" x 0.032 wall copper tracer.

For specific information regarding each of these products, consult the factory or your local representative.

### Dimensions

	NOMINAL WT. LB/FT (KG/M)	NOMINAL DIMENSIONS - IN (CM)	
		A	B
<b>TPL1</b> - One 3/8" Process with 3/8" Tracer	0.63 (0.94)	2.0 (5.1)	1.6 (4.1)
<b>TPL1</b> - One 1/2" Process with 3/8" Tracer	0.81 (1.21)	2.2 (5.6)	1.7 (4.3)
<b>TPL1</b> - One 1/2" Process with 1/2" Tracer	0.85 (1.26)	2.2 (5.6)	1.7 (4.3)
<b>TPL2</b> - Two 3/8" Process with 3/8" Tracer	0.87 (1.26)	2.3 (5.8)	1.6 (4.1)
<b>TPL2</b> - Two 1/2" Process with 3/8" Tracer	1.09 (1.62)	2.7 (6.9)	1.7 (4.3)
<b>TPL2</b> - Two 1/2" Process with 1/2" Tracer	1.13 (1.68)	2.7 (6.9)	1.7 (4.3)

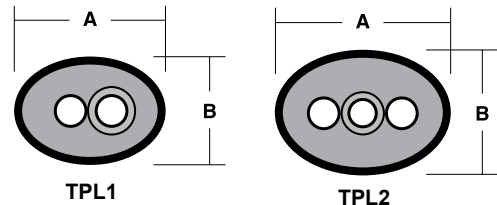

### TWO 1/2" (12mm) PROCESS LINES WITH ONE 1/2" (12mm) TRACER TYPICAL PERFORMANCE

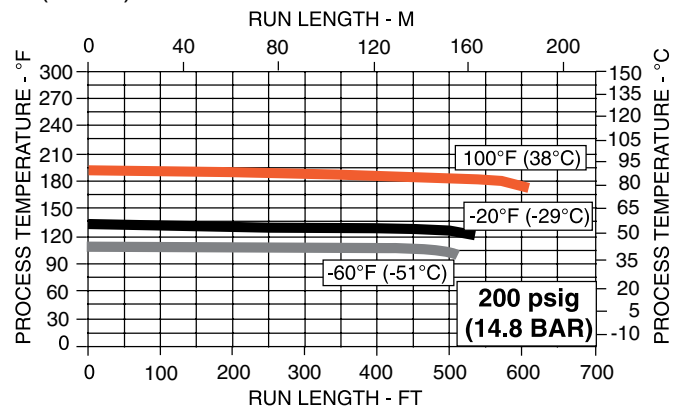



# TPH HEAVY STEAM TRACING

A preinsulated tubing bundle with heavy steam tracing



Heavy tracing keeps the process tubing in direct contact with the tracer and maintains higher process temperatures.

TPH is recommended for use on analyzer sample transport and instrumentation impulse lines. It is also recommended for additives and other small diameter process lines where higher temperature maintenance or viscosity control is necessary.

### Model Number

#### Product Family

**TPH1**-Preinsulated Heavy Steam Traced Single Process Tube

**TPH2**-Preinsulated Heavy Steam Traced Dual Process Tubes

#### Jacket

**S** - SV47 (PVC)

**U** - TPU (Polyurethane)

*This is a condensed list of tube and tracer options. For a full product offering consult factory.*

#### Process Tube

- A2** 1/4" x 0.035 wall welded 316SS
- A3** 3/8" x 0.035 wall welded 316SS
- A4** 1/2" x 0.035 wall welded 316SS
- E4** 1/2" x 0.049 wall welded 316SS
- F1** 1/8" x 0.035 wall seamless 316SS
- F2** 1/4" x 0.035 wall seamless 316SS
- F3** 3/8" x 0.035 wall seamless 316SS
- F4** 1/2" x 0.035 wall seamless 316SS
- B2** 1/4" x 0.049 wall seamless 316SS
- B3** 3/8" x 0.049 wall seamless 316SS
- B4** 1/2" x 0.049 wall seamless 316SS
- B6** 3/4" x 0.049 wall seamless 316SS
- K4** 1/2" x 0.065 wall seamless 316SS
- G2** 1/4" x 0.030 wall PFA
- G3** 3/8" x 0.030 wall PFA
- H3** 3/8" x 0.062 wall PFA
- H4** 1/2" x 0.062 wall PFA
- S2** 1/4" x 0.040 wall PFA
- MF6** 6mm x 1mm wall seamless 316SS
- MF8** 8mm x 1mm wall seamless 316SS
- MF10** 10mm x 1mm wall seamless 316SS
- MF12** 12mm x 1mm wall seamless 316SS
- MB10** 10mm x 1.5mm wall seamless 316SS
- MB12** 12mm x 1.5mm wall seamless 316SS

- MG6** 6mm x 1mm wall PFA
- MG8** 8mm x 1mm wall PFA
- MG10** 10mm x 1mm wall PFA
- MG12** 12mm x 1mm wall PFA
- MA12** 12mm x 1mm wall welded 316SS
- N2** 1/4" x 0.035 wall seamless Alloy 400
- N3** 3/8" x 0.035 wall seamless Alloy 400
- P4** 1/2" x 0.049 wall seamless Alloy 400

#### Tracer

- A2** 1/4" x 0.035 wall welded 316SS
- A3** 3/8" x 0.035 wall welded 316SS
- A4** 1/2" x 0.035 wall welded 316SS
- F2** 1/4" x 0.035 wall seamless 316SS
- F3** 3/8" x 0.035 wall seamless 316SS
- B4** 1/2" x 0.049 wall seamless 316SS
- J2** 1/4" x 0.030 wall copper
- C3** 3/8" x 0.032 wall copper
- M4** 1/2" x 0.049 wall copper
- MF6** 6mm x 1mm wall seamless 316SS
- MF8** 8mm x 1mm wall seamless 316SS
- MF10** 10mm x 1mm wall seamless 316SS
- MF12** 12mm x 1mm wall seamless 316SS
- MD6** 6mm x 1mm wall copper
- MD8** 8mm x 1mm wall copper
- MD10** 10mm x 1mm wall copper
- MD12** 12mm x 1mm wall copper

#### Example:

##### TPH2S-A4-C3

Two 1/2" x 0.035 wall 316SS welded process lines with an SV47 jacket and 3/8" x 0.032 wall copper tracer.

For specific information regarding each of these products, consult the factory or your local representative.

### Dimensions

	NOMINAL WT. LB/FT (KG/M)	NOMINAL DIMENSIONS - IN (CM)	
		A	B
<b>TPH1- One 3/8" Process with 3/8" Tracer</b>	0.5 (0.74)	1.5 (3.8)	1.2 (3.0)
<b>TPH1- One 1/2" Process with 3/8" Tracer</b>	0.6 (0.89)	1.6 (4.1)	1.2 (3.0)
<b>TPH1- One 1/2" Process with 1/2" Tracer</b>	0.7 (1.04)	1.7 (4.3)	1.2 (3.0)
<b>TPH2- Two 3/8" Process with 3/8" Tracer</b>	0.6 (0.89)	2.0 (5.1)	1.2 (3.0)
<b>TPH2- Two 1/2" Process with 3/8" Tracer</b>	0.7 (1.04)	2.1 (5.4)	1.2 (3.0)
<b>TPH2- Two 1/2" Process with 1/2" Tracer</b>	0.8 (1.19)	2.2 (5.6)	1.2 (3.0)

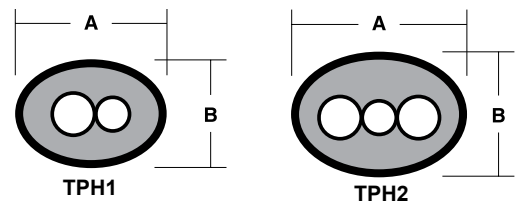

### TWO 1/2" (12mm) PROCESS LINES WITH ONE 3/8" (10mm) TRACER TYPICAL PERFORMANCE

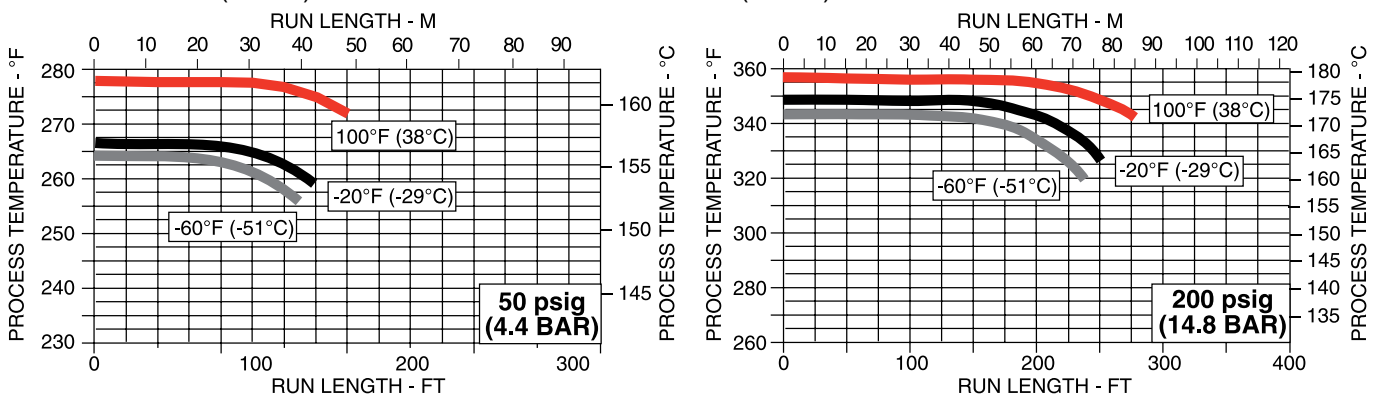

# S-LINE® & J-LINE®

## S-LINE: A weather-proofed, preinsulated single tubing line

S-LINE is suggested for 1" (25mm) and smaller steam, condensate, liquid and gas transport lines where personnel protection and heat loss are important. S-LINE offers an inexpensive alternative to field insulation and weatherproofing of small diameter lines.

## J-LINE: A weather-proofed, single tubing line

J-Line tubing is designed for pneumatic and hydraulic applications in corrosive atmospheres. Industry standard tubing coated with O'Brien SV47 (PVC) polymer provides increased protection against galvanic and atmospheric corrosion as well as cushioning the tube against wear from vibration.



### Model Number

#### Product Family

S-Preinsulated Single Process Tube with an SV47 Jacket

J-Single Process Tube with an SV47 Jacket

#### Process Tube

- A2 1/4" x 0.035 wall welded 316SS
- A3 3/8" x 0.035 wall welded 316SS
- A4 1/2" x 0.035 wall welded 316SS
- E4 1/2" x 0.049 wall welded 316SS
- F1 1/8" x 0.035 wall seamless 316SS
- F2 1/4" x 0.035 wall seamless 316SS
- F3 3/8" x 0.035 wall seamless 316SS
- F4 1/2" x 0.035 wall seamless 316SS
- B2 1/4" x 0.049 wall seamless 316SS
- B3 3/8" x 0.049 wall seamless 316SS
- B4 1/2" x 0.049 wall seamless 316SS
- B6 3/4" x 0.049 wall seamless 316SS
- J2 1/4" x 0.030 wall copper
- C3 3/8" x 0.032 wall copper
- D4 1/2" x 0.035 wall copper
- M4 1/2" x 0.049 wall copper
- M6 3/4" x 0.049 wall copper
- MF6 6mm x 1mm wall seamless 316SS
- MF8 8mm x 1mm wall seamless 316SS
- MF10 10mm x 1mm wall seamless 316SS
- MF12 12mm x 1mm wall seamless 316SS
- MB10 10mm x 1.5mm wall seamless 316SS
- MB12 12mm x 1.5mm wall seamless 316SS

### Examples:

#### SC3

One preinsulated 3/8" x 0.032 wall copper process line with an SV47 jacket.

#### JC3

One 3/8" x 0.032 wall copper process line with an SV47 jacket.

For specific information regarding each of these products, consult the factory or your local representative.

### Dimensions

	NOMINAL WT. LB/FT (KG/M)	NOMINAL DIMENSIONS A - IN (CM)
S-LINE- One 1/4" Process Line	0.2 (0.30)	1.0 (2.5)
S-LINE- One 3/8" Process Line	0.3 (0.45)	1.1 (2.8)
S-LINE- One 1/2" Process Line	0.4 (0.60)	1.2 (3.0)

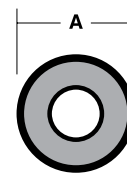

S-LINE

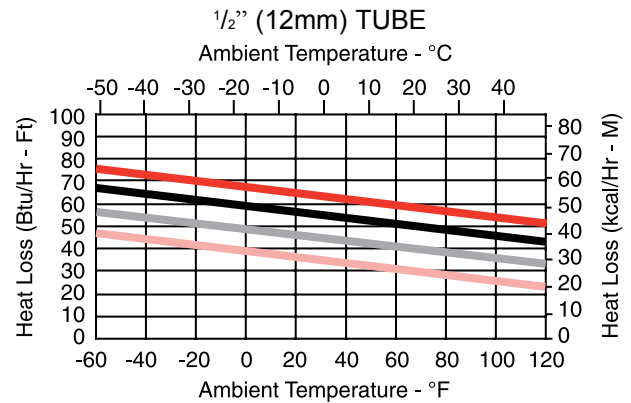
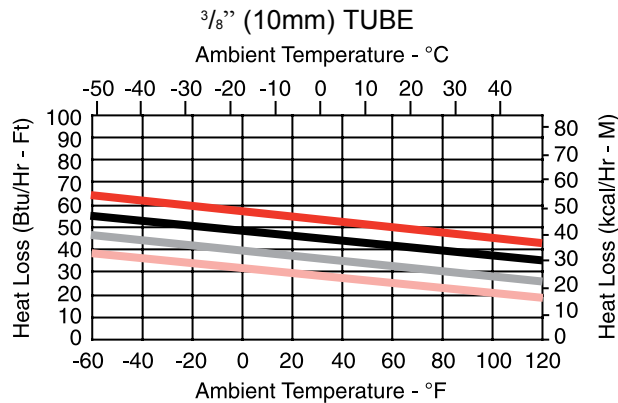

- 200 psig (15 BAR) steam
- 125 psig (9.5 BAR) steam 353°F
- 50 psig (4.5 BAR) steam 299°F
- 15 psig (2.0 BAR) steam 250°F



# STACKPAK, TRACEPAK MJ & CUSTOM DESIGNS



## Solutions for unique applications

In addition to conventional TRACEPAK designs, O'Brien can satisfy your special needs with custom solutions. Modeling for these designs is verified in our environmental chamber under conditions insuring a tubing bundle that meets your exact requirements, with reliability and accuracy you can depend on.

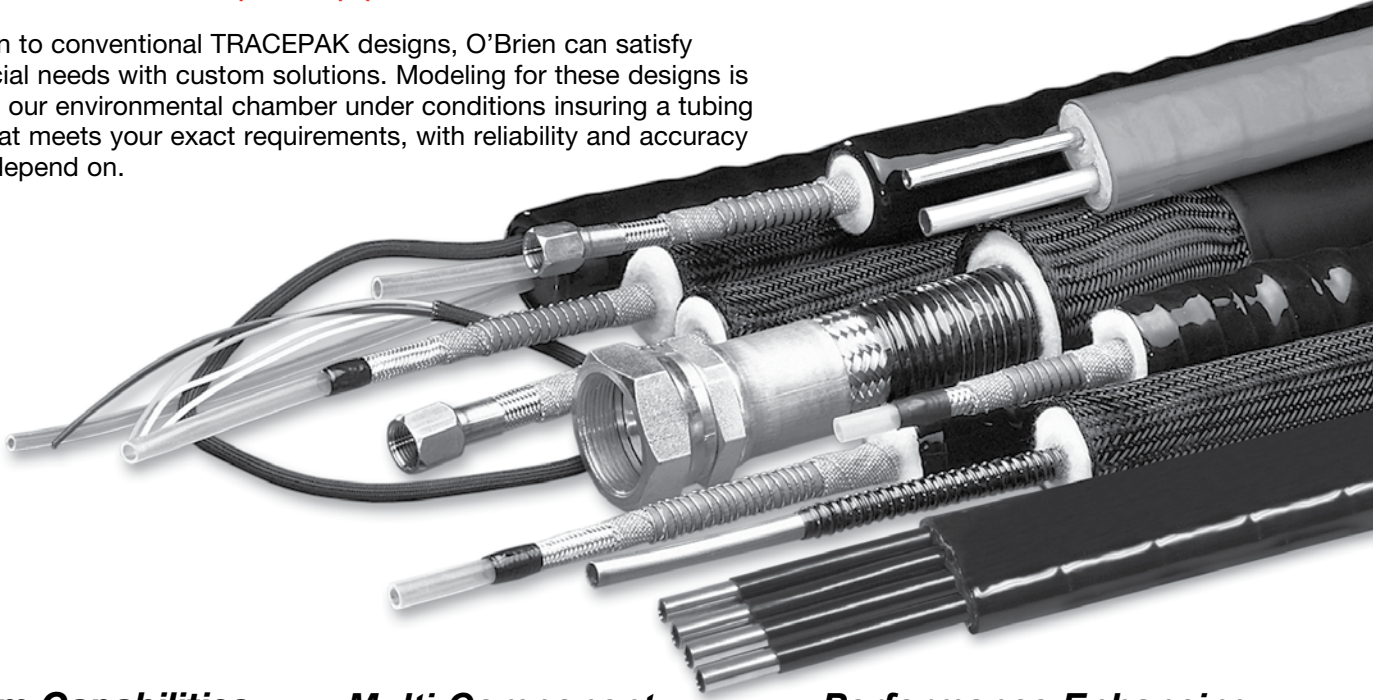

### **Custom Capabilities**

- Indoor & Outdoor Jackets
- Maintenance Temperatures to 660°F (350°C)
- Custom Lengths
- Choice of Process Connection Fittings
- Pre-terminated and Fitted Ends
- Factory Installed Temperature Sensors
- Communication, Monitor and Power Wires
- Alternate Jacket Colors

### **Unusual Tube Material Nonstandard Sizes**

TRACEPAK can be manufactured with a wide range of uncommon materials and sizes to conform to your unique material requirements, including:

- Fluoropolymer variations such as PTFE, PFA, TFE, and nylon.
- Hastelloy
- Incoloy
- Titanium
- Duplex and Super Duplex
- 6% Moly
- Oxygen Cleaned Tubes
- Chemically Polished Stainless Steel with SilcoNert 2000
- Electropolished Stainless Steel with SilcoNert 2000

### **Multi-Component Bundles**

Complex designs incorporate factory installed temperature sensors such as RTD's, PT100's thermocouples with multiple process tubes, calibration gas supply tubes, tracers, communication wires, power wiring, and heat tracing.

### **High Temperature Heaters**

Specialty tracers such as CPD, MI and resistance wires can be used to provide temperature maintenance up to 660°F (350°C) and to withstand a high temperature blowdown of 1150°F (620°C).

### **Jacket Materials for Diverse Applications**

Jacket materials are available to withstand high operating temperatures, permit installation at low ambients or stand up to constant flexing. Materials include polyurethane, polyethylene or PVC for outdoor applications, and polyethylene braid or stainless steel braid for indoor applications.

### **Performance Enhancing Designs**

Special insulated or buffered designs are available for applications with high intermittent process temperatures. These designs insulate the standard self-limiting tracer from the process tube to allow higher maximum exposure temperatures while still providing freeze protection.

### **Typical Applications**

#### *Sampling Systems*

Emissions Gas Sampling,  
Process and Portable Analyzers  
Automotive Emissions Testing

#### *Viscosity Control*

Petroleum products, Asphalt, Tar,  
Paint Systems, Printing Ink, Coatings,  
Spray Foam Insulation

#### *Product Transfer*

Polymers, Oils, Urethanes, Waxes,  
Chemicals, Food Products, Hot Melt  
Adhesives, Sanitary and High Purity  
Applications

#### *Corrosion Protection*

Jacketed tubing for harsh  
environments such as Marine  
and Offshore.

®Silcosteel and Sulfinert are registered trademarks of Restek Corporation.

# ACCESSORIES Sealing the Bundle

Although TRACEPAK products use a non-hygroscopic, non-wicking insulation, all bundle ends must be sealed to prevent any possible moisture contamination.

## TPKSK-10 - Silicone Sealant

This option is used to seal both ends of the tubing bundle from moisture. It is a black silicone RTV sealant. Cure time is approximately 24 hours at 77°F (25°C). Service temperature ranges from -50°F (-45°C) to 400°F (205°C). TPKSK offers excellent resistance to weather, oil and many chemicals.

To Order: **TPKSK-10** End Seal Kit, RTV Sealant, 10 oz. will seal approximately 10 ends



## TPKJP-SR-B - Self Bonding Silicone Tape

This option is used to seal both ends of the tubing bundle from moisture. It is a black silicone, self bonding.

To Order: **TPKJP-SR-B** Self Bonding Tape, 36 yd (33m)

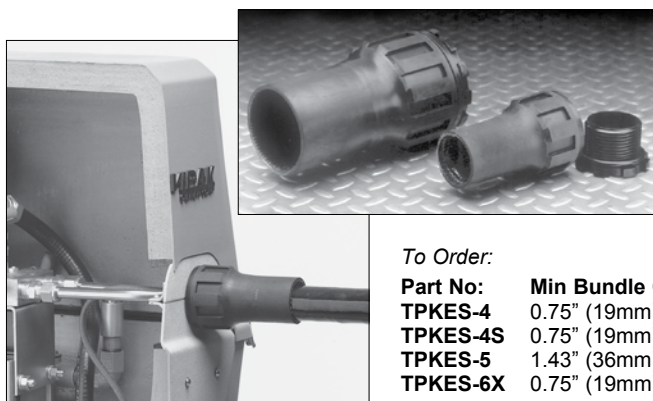

## TPKES - Heat Shrink Entry Seal

The heat-shrinkable entry seal provides a waterproof fitting where TRACEPAK enters an enclosure. They can be added to parting line or surface mounted plates on VIPAK enclosures. The thermally stabilized, modified polyolefin entry seal consists of a threaded assembly that seals at the enclosure and a heat-shrinkable nose that seals to the TRACEPAK bundle.

To Order:

Part No:	Min Bundle OD	Max Bundle OD	Max Panel Thickness
<b>TPKES-4</b>	0.75" (19mm)	1.60" (40mm)	0.50" (12mm)
<b>TPKES-4S</b>	0.75" (19mm)	2.10" (53mm)	0.50" (12mm)
<b>TPKES-5</b>	1.43" (36mm)	2.90" (74mm)	0.75" (19mm)
<b>TPKES-6X</b>	0.75" (19mm)	3.50" (90mm)	0.75" (19mm)

## TPKHS - Heat Shrink Boots

The heat-shrinkable boots provide a weatherproof end seal for TRACEPAK tubing bundles. They are made of thermally stabilized, modified polyolefin. Using a heat shrink end seal boot is recommended for all exposed ends. This installation will provide the best weather seal protection.

To Order:

- TPKHS-A3** TPL2, TPH2 with process tubes greater than 3/8" and 1/4" tracers.  
TPE2 with tubes greater than 3/8"
- TPKHS-B3** TPE2, TPL2, or TPH2 all with process tubes 3/8" or smaller
- TPKHS-H3** TPL2 wi E1 with 3/8" or larger tubes. TPL1 with 1/4" tracers
- TPKHS-L2** TPL1 with tracers larger than 1/4"
- TPKHS-D2** TPE1 with 1/4" tube
- TPKHS-E1** S-LINE and TPS1

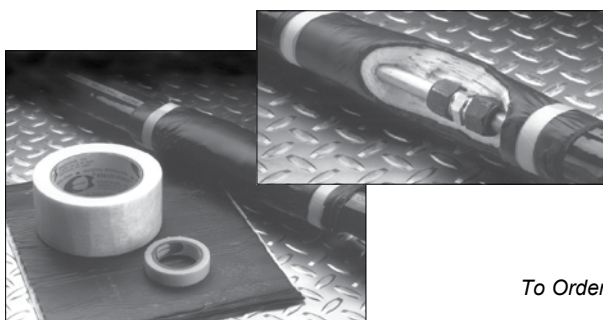
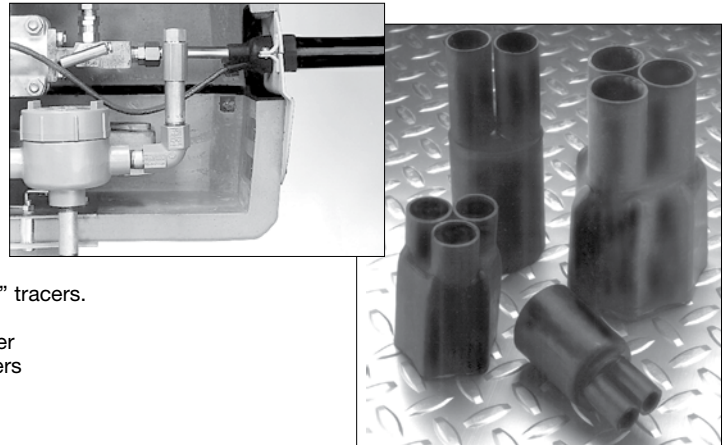

## TPKJP - Jacket Patch

The jacket patch kits are used to seal a splice in a bundle or to extend the insulation and weatherproof jacket should the bundle be cut back too far during installation. They are used as a repair patch for any incidental field damage to bundles. The jacket patch kit is required with the optional line temperature sensing thermostat. Each kit contains thermal insulation, fiberglass tape and a self-sealing patch.

To Order:

	Bundles up to 400°F (204°C)	Bundles up to 1150°F(590°C)
Small 8" x 12"	<b>TPKJP-1</b>	<b>TPKJP-3</b>
Large 8" x 96"	<b>TPKJP-2</b>	<b>TPKJP-4</b>



## ACCESSORIES Temperature Control

# O'BRIEN

### SensorTube™

**G2S** - 1/4" x 0.030 PFA

**G3S** - 3/8" x 0.030 PFA

SensorTube creates a pathway for the RTD kit to be positioned up to 15' (4.5m) from the control end without any special tools. This eliminates cutting into the bundle with field installed RTDs. The specially sized bulb and lead construction of the kit can be easily inserted into the bundle even after it is installed. The RTD kit has been inserted through more than five ninety degree bends without problems.

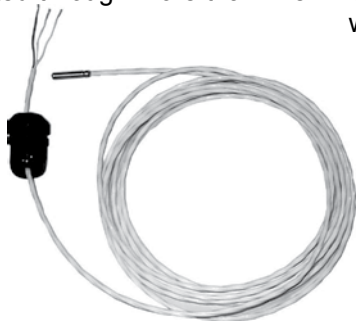

### RTD Kit

RTD Kit includes a 100 Ohm / PT100, 3 wire sensor with 20' (6m) of fluoropolymer jacketed leads and an entry seal.

To Order: **RTDKIT20** 100 Ohm / 100PT three wire RTD Kit for use with 1/4" or 3/8" SensorTube.

Consult factory for bundle designs with SensorTube.

### 1017 Series Controllers

The 1017 Series controllers are compact, full featured, microprocessor based single and dual point heat trace controllers. They provide control and monitoring of Tracepak and Stackpak tubing bundles designed for freeze protection and temperature maintenance. The controllers can be set to monitor and alarm high and low temperature, high and low current, ground fault trip and voltage. The controllers are supplied with a solid-state relay (SSR) for use in nonhazardous and Class I Div. 2 / Zone 2 hazardous areas.

For ordering information consult bulletin QLT-1017



### Thermostats

When used with electrically traced tubing bundles, optional thermostats are used to control the temperature of the process tube or to turn on the heater circuit at a specified ambient temperature.



Note:  
Models shown are typical of thermostats supplied.  
Units received may differ depending on approvals.

### Ambient Sensing

The ambient sensing thermostat has an adjustable set point of 15°F to 140°F (-9°C to 60°C) and can withstand ambient temperatures of -40°F to 160°F (-40°C to 71°C). It has a fluid filled stainless steel probe and the SPDT switch is rated for 22A at 125/250/480 VAC. It is UL listed and CSA certified for use in hazardous areas.

To Order: **TPKTS-A-7** Ambient Sensing Thermostat, NEMA 7 Housing, 22 amp 125/250 VAC

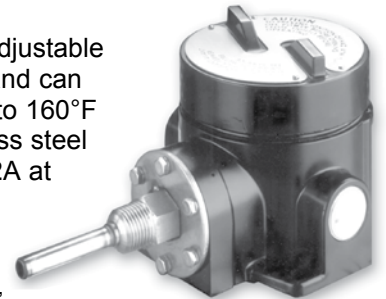

### Line Sensing or Ambient Sensing

The line sensing thermostat controls the temperature of the process tubes. It has an adjustable set point of 25°F to 325°F (-4°C to 163°C) and can withstand process temperatures from -40°F to 420°F (-40°C to 215°C). The fluid filled stainless steel bulb has a 10' capillary. The SPDT switch is rated for 22A at 125/250/480 VAC. Model TPKTS-B-7 is UL and FM listed and CSA certified for use in hazardous areas. Model RAYSTAT-EX-02 is EEx d approved for use in hazardous areas.

To Order: **TPKTS-B-7** Line Sensing Thermostat, NEMA 7 Housing, 22 amp 125/250 VAC



## ACCESSORIES Power & Termination Kits



### Power Connection Kits

#### **T210-PC**

FM Approved and CSA Certified Class I Div. 2 power connection kit for use with any wattage B, N, J, P, JV or JN tracer. Includes junction box and bundle mounting bracket with adjustable straps. Junction box also includes surface mounting feet.

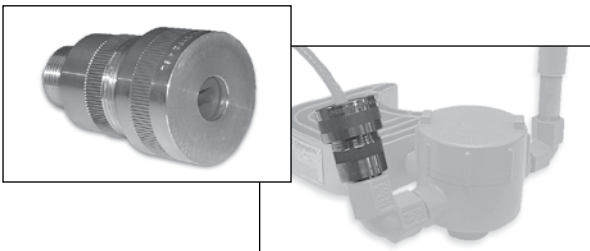

#### **TPC1**

CSA Certified Class I Div. 1 power connection or end termination kit for use with any wattage B, N, J or P tracer. Installs in customer supplied junction box with 1/2" npt hub.

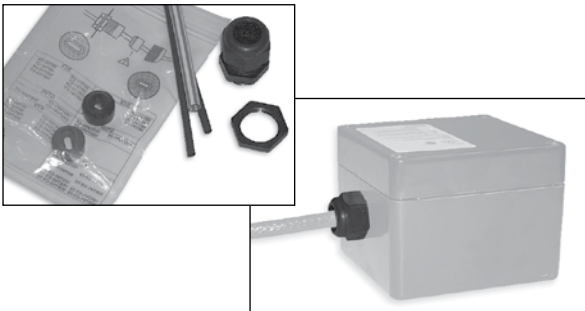

#### **T9355-PC**

ATEX standards approved power connection kit for use with any wattage B, N, J, P, JV or JN tracer. For use with customer supplied junction box.



### End Termination Kits

#### **T210-ET**

FM Approved and CSA Certified Class I Div. 2, and ATEX EEx ell listed electric tracer termination kit for use with any wattage B, N, J or P tracer.



#### **T355-ET**

ATEX standards approved electric tracer termination kit for use with any wattage B, N, J, P, JV or JN tracer.

## ACCESSORIES Installation Tools

# O'BRIEN

TRACEPAK is designed to be installed using standard bending tools. We offer two specialized tools that make installation of TRACEPAK tube bundles easier and more compact.

### **Bundle Bending Tool**

Similar to a common electrical conduit bender, this tool is compact and easy to use. It eliminates the need for larger and heavier benders that have 8" (200mm) and 12" (300mm) minimum bending radius.

To Order:

**BB8** Bundle Bending Tool with 8" (200mm) Radius  
**BB12** Bundle Bending Tool with 12" (300mm) Radius

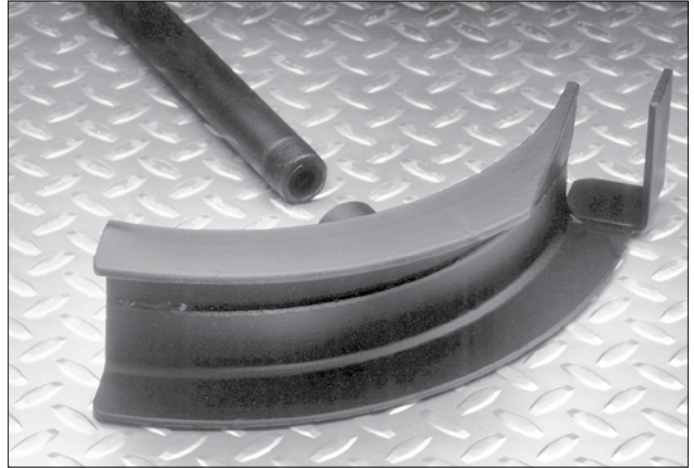

### **2 1/8" (54mm) Centerline Tool**

A replacement for the standard tube bender, it brings the process tubes to the correct centerline for connecting to typical transmitters. This tool makes back-to-back bends easier accomplishing the bends in a much shorter distance than possible with a standard tube bender.

To Order: Centerline-Tool

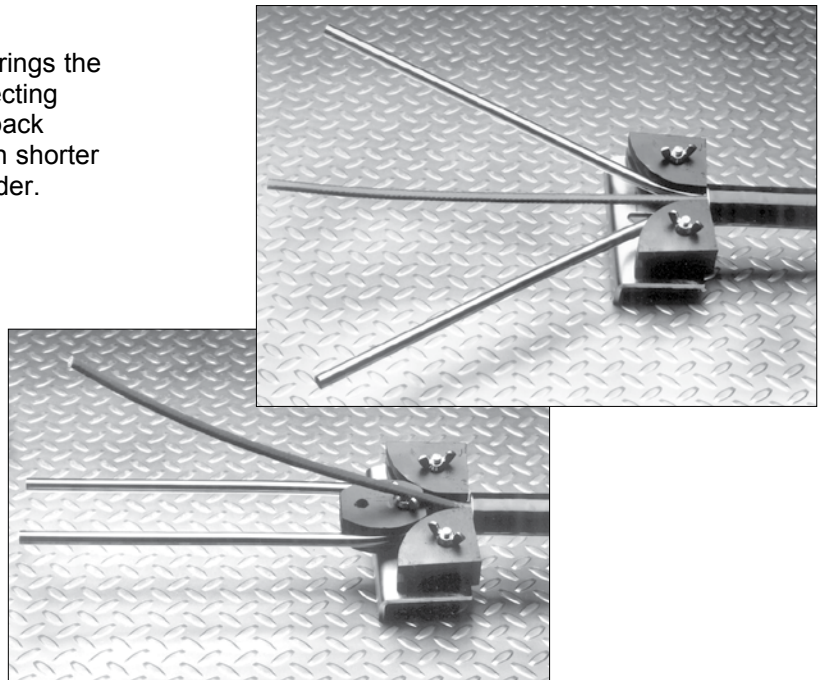
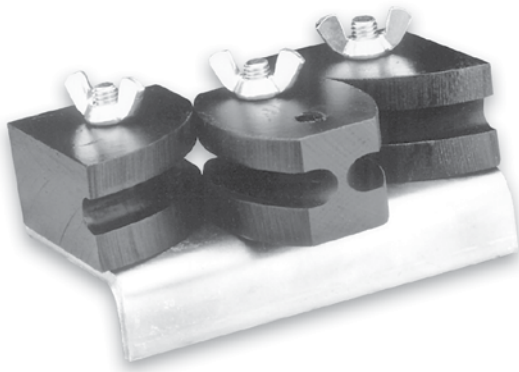

### **Installation DVD**

Helpful information on the installation of TRACEPAK tubing bundles. The DVD deals with general installation procedures and gives a good overview of the products and accessories available to complement and complete the total package.

To Order: Installation-CD

# DESIGN REQUEST

The TRACEPAK® DESIGN REQUEST is also available online at [www.obcorp.com/DesignRequest.htm](http://www.obcorp.com/DesignRequest.htm)



sales.obrien@ametech.com • www.obcorp.com

Required By: \_\_\_\_\_

From:

End User:

Date:

Notes:

## SITE CONDITIONS

Outdoor  Indoor Low Ambient \_\_\_\_\_ °F/C High Ambient \_\_\_\_\_ °F/C Wind 25mph

## HEATING CONDITIONS

Desired Maintenance Temperature \_\_\_\_\_ °F/C

Minimum Maintain \_\_\_\_\_ °F/C Maximum Maintain \_\_\_\_\_ °F/C

If an Analyzer Line what is the inlet temperature of gas? \_\_\_\_\_ °F/C

## PROCESS TUBING

Quantity \_\_\_\_\_ ft. Are Exact Cut Lengths Required? \_\_\_\_\_ ft.

Number of Process Tubes \_\_\_\_\_

O.D. of #1 Process Tube \_\_\_\_\_ in. Welded or Seamless?

Wall Thickness \_\_\_\_\_ in. Material of Construction \_\_\_\_\_

O.D. of #2 Process Tube \_\_\_\_\_ in. Welded or Seamless?

Wall Thickness \_\_\_\_\_ in. Material of Construction \_\_\_\_\_

## IF ELECTRIC TRACING

Electrical Voltage \_\_\_\_\_ VAC Area Classification \_\_\_\_\_ Division \_\_\_\_\_

Will Steam be used to blow down this bundle? \_\_\_\_\_ What Temperature or bar \_\_\_\_\_ °F/C

## IF STEAM TRACING

Steam Pressure \_\_\_\_\_ psig Temperature \_\_\_\_\_ °F/C

Maximum Blow Down Temperature \_\_\_\_\_ °F/C

O.D. Tracer Tube \_\_\_\_\_ in. Welded or Seamless?

Wall Thickness \_\_\_\_\_ in. Material of Construction \_\_\_\_\_

## ACCESSORIES

Heat Shrink Boots

Entry Fittings

SensorTube™

Thermostats

Power Kits

RTD / PT100 Kits

Termination Kits

Splice Kits

Controllers

Jacket Patch Kits

Silicone End Sealant

Installation DVD

## OTHER TRACING LIQUIDS - Flow must be turbulent

Flow Rate \_\_\_\_\_ lbs/hr

Specific Heat \_\_\_\_\_ Btu/lb°F

Minimum Inlet Temperature (for heating) \_\_\_\_\_ °F/C

Maximum Inlet Temperature (for cooling) \_\_\_\_\_ °F/C

Density \_\_\_\_\_ lb/ft³ Viscosity \_\_\_\_\_ centipoise

## HEAT EXCHANGER APPLICATIONS - Flow must be turbulent

LIQUID OR GAS

Flow Rate \_\_\_\_\_ lb/hr Temperature at inlet \_\_\_\_\_ °F/C

Desired Temperature at Outlet \_\_\_\_\_ °F/C Density \_\_\_\_\_ lb/ft³

Maximum allowable outlet temp \_\_\_\_\_ °F/C Viscosity \_\_\_\_\_ centipoise

Minimum allowable outlet temp \_\_\_\_\_ °F/C Specific Heat \_\_\_\_\_ Btu/hr°F

Thermal Conductivity \_\_\_\_\_ Btu.hr ft²°F

(O'Brien will determine minimum length for heat exchanger applications)

NOTES:



# TUBE SPECIFICATIONS

# O'BRIEN

This is a condensed list of tube and tracer options. For a full product offering consult factory.

Designation	OD	Wall	Material	Construction	ASTM
F1	1/8"	0.035"	316/316L SS	Seamless	A269, A213-EAW
F2	1/4"	0.035"	316/316L SS	Seamless	A269, A213-EAW
F3	3/8"	0.035"	316/316L SS	Seamless	A269, A213-EAW
F4	1/2"	0.035"	316/316L SS	Seamless	A269, A213-EAW
B2	1/4"	0.049"	316/316L SS	Seamless	A269, A213-EAW
B3	3/8"	0.049"	316/316L SS	Seamless	A269, A213-EAW
B4	1/2"	0.049"	316/316L SS	Seamless	A269, A213-EAW
B6	3/4"	0.049"	316/316L SS	Seamless	A269, A213-EAW
K4	1/2"	0.065"	316/316L SS	Seamless	A269, A213-EAW
K8	1"	0.065"	316/316L SS	Seamless	A269, A213-EAW
A2	1/4"	0.035"	316/316L SS	Welded	A269
A3	3/8"	0.035"	316/316L SS	Welded	A269
A4	1/2"	0.035"	316/316L SS	Welded	A269
E4	1/2"	0.049"	316/316L SS	Welded	A269
N2	1/4"	0.035"	Alloy 400	Seamless	B163, B165
N3	3/8"	0.035"	Alloy 400	Seamless	B163, B165
P4	1/2"	0.049"	Alloy 400	Seamless	B163, B165
J2	1/4"	0.030"	Copper	Seamless	B68, B75
C3	3/8"	0.032"	Copper	Seamless	B68, B75
D4	1/2"	0.035"	Copper	Seamless	B68, B75
M4	1/2"	0.049"	Copper	Seamless	B68, B75
M6	3/4"	0.049"	Copper	Seamless	B68, B75
G2	1/4"	0.030"	PFA	Extruded	
S2	1/4"	0.040"	PFA	Extruded	
G3	3/8"	0.030"	PFA	Extruded	
H3	3/8"	0.062"	PFA	Extruded	
H4	1/2"	0.062"	PFA	Extruded	
MF6	6mm	1mm	316/316L SS	Seamless	A269, A213-EAW, DIN 17458 1.4401/1.4404
MF8	8mm	1mm	316/316L SS	Seamless	A269, A213-EAW, DIN 17458 1.4401/1.4404
MF10	10mm	1mm	316/316L SS	Seamless	A269, A213-EAW, DIN 17458 1.4401/1.4404
MF12	12mm	1mm	316/316L SS	Seamless	A269, A213-EAW, DIN 17458 1.4401/1.4404
MB10	10mm	1.5mm	316/316L SS	Seamless	A269, A213-EAW, DIN 17458 1.4401/1.4404
MB12	12mm	1.5mm	316/316L SS	Seamless	A269, A213-EAW, DIN 17458 1.4401/1.4404
MD6	6mm	1mm	Copper	Seamless	B68, B75
MD8	8mm	1mm	Copper	Seamless	B68, B75
MD12	12mm	1mm	Copper	Seamless	B68, B75
MG6	6mm	1mm	PFA	Extruded	
MG8	8mm	1mm	PFA	Extruded	
MG10	10mm	1mm	PFA	Extruded	
MG12	12mm	1mm	PFA	Extruded	
MA12	12mm	1mm	316/316L SS	Welded	ASTM, A269

## JACKET

**TPU** – Thermoplastic Polyether Urethane Elastomer

- Hydrolytically Stabilized
- Halogen Free
- Excellent Abrasion Resistance
- Excellent UV Resistance

**SV47** – Formulated PVC

- Economical
- Low Temperature Formulation
- UV Resistant Additives

## INSULATION

- Fibrous Glass
- Water Soluble Chlorides less than 100 ppm.
- Non-hygroscopic

## TEMPERATURE LIMITS

Jacket	Min Installation	Min Service
<b>TPU</b>	-40°F/-40°C	-67°F/-58°C
<b>SV47</b>	-10°F/-23°C	-30°F/-35°C

Maximum jacket surface temperature  
140°F (60°C) at ambient temperature of  
80°F (27°C) with maximum process or  
tracer tube temperature.

## TPH, TPL and S-LINE

Maximum process tube temperature  
400°F (204°C)\*

## TPE

Continuous exposure power on.

**High Temperature Tracer**

250°F (120°C)\*

**Low Temperature Tracer**

150°F (65°C)\*

Intermittent exposure power on or off.

**High Temperature Tracer**

482°F (250°C)\*

**Low Temperature Tracer**

185°F (85°C)\*

Maximum tracer temperature

**High Temperature Tracer**

T-rating T3, 392°F (200°C)

except 20 w/ft T2 446°F (230°C)

**Low Temperature Tracer**

T-rating T6, 185°F (85°C)

\*Consult factory for higher temperature limits.

## Customer Service

O'Brien's reputation as a customer oriented problem solver has been long recognized.

Our customer-oriented approach offers:

- Responsive, knowledgeable personnel.
- Unparalleled delivery service.
- Dependable, tested results of all product lines.
- On-line order status and shipment tracking.

## ISO 9001

Unparalleled quality system to current ISO 9001 standards.

O'Brien's adherence to recognized international standards is your strongest assurance of our quality.

## Total Solution

O'Brien products and solutions improve instrument accuracy.

Our total engineering package will reduce field installation costs and provide a dependable solution for your needs.

BELGIUM • BRAZIL • CHINA • RUSSIA • SINGAPORE • SOUTH KOREA • USA  
[www.obcorp.com](http://www.obcorp.com)

Specifications subject to change without notice.

© 2015, by AMETEK, Inc. All rights reserved • QLT-TPBR • 20 JULY 2015

[sales.obrien@ametek.com](mailto:sales.obrien@ametek.com)

